



ELSEVIER

International Journal of Mass Spectrometry 206 (2001) 91–103



# Definitive characterization of some $C_5H_5N^+$ and $C_6H_7N^+$ radical cations by associative ion–molecule reactions

Pascal Gerbaux<sup>a1</sup>, Monique Barbieux-Flammang<sup>a</sup>, Johan K. Terlouw<sup>b</sup>,  
Robert Flammang<sup>a,\*</sup>

<sup>a</sup>Organic Chemistry Laboratory, University of Mons-Hainaut, 19, Avenue Maistriau, 7000 Mons, Belgium

<sup>b</sup>Department of Chemistry, McMaster University, 1280 Main Street West, Hamilton, Ontario L8S 4M1, Canada

Received 1 September 2000; accepted 10 October 2000

## Abstract

Isomeric  $C_5H_5N^+$  and  $C_6H_7N^+$  radical cations were allowed to interact with various neutral reagents in the quadrupole collision chamber of a six sector magnetic deflection type tandem mass spectrometer. Using  $CH_3SSCH_3$ ,  $CH_3OH$ , or  $H_2O$ , iso- $C_3H_7I$ , and tert- $C_4H_9NC$  as substrates, specific associative ion–molecule reactions occur whose products were analyzed in a subsequent high energy collision induced dissociation experiment. Differentiation between ionized pyridine and its 1,2-H shift isomer is readily achieved with each of the four substrates as the latter  $C_5H_5N^+$  ion exhibits a radical-type reactivity characteristic of its distonic character. An unambiguous structure characterization of the  $C_6H_7N^+$  ions, namely ionized 2-methylpyridine, the *N*-methylene pyridinium ylide ion, the 2-methylene-1-hydropyridine ion, and the *N*-methyl-2-dehydropyridine radical cation, is realized when all of the above substrates are used in the analysis. (Int J Mass Spectrom 206 (2001) 91–103) © 2001 Elsevier Science B.V.

**Keywords:** Tandem mass spectrometry; Associative ion–molecule reactions; Distonic ions; Collision-induced dissociation

## 1. Introduction

The structure assignment of an organic ion in the gas phase is commonly based on information derived from either its dissociation chemistry or its reactivity in selected ion–molecule reactions. The methodology used in the former approach probes the collision induced (CID) and spontaneous dissociations of the ions (and selected labeled isotopologues) and, when combined with energetic information derived from

experiment and/or theoretical calculations, often leads to a definitive structure assignment [1]. However, deriving the structure of a given ion from its dissociation chemistry may become problematic when isomeric structures with energetically more favourable dissociation routes are accessible. This phenomenon may dominate a CID spectrum to such an extent that tell-tale peaks for structure specific dissociation reactions are largely suppressed or even absent [2].

In the second approach, the reactivity of the ion under investigation is probed by interactions with selected neutral molecules [3]. Apart from charge exchange and protonation reactions, highly structure specific associative ion–molecule reactions may occur

\* Corresponding author. E-mail: Robert.Flammang@umh.ac.be

<sup>1</sup> Chargé de Recherches du Fonds National de la Recherche Scientifique

that can serve to easily distinguish the ion from its structurally related isomers. A couple of examples of the success of this approach (where CID experiments were inconclusive) involve the differentiation of the *C*- and *S*-sulfide ethenedithione ions  $\text{SCCS}_2^+$  and  $\text{SCCSS}^+$  [4] and the characterization of isomeric  $\text{C}_4\text{H}_4^+$  ions [3e,5].

On the other hand, the interaction of an ion with an appropriately chosen neutral molecule may also lead to a facile isomerization, by way of proton transport catalysis and related mechanisms [6]. Nevertheless, the virtually unlimited choice of neutral molecules makes the ion–molecule approach quite versatile and eminently suited as a complementary tool to study systems of isomeric ions whose basic isomerization and dissociation characteristics have been probed by theory and/or experiment.

A case in point are the three 1,2-H shift isomers of the pyridine radical cation  $\mathbf{1}^{+\bullet}$  which have been thoroughly characterized by various collision experiments and theoretical calculations [7]. The high-energy CID spectra of the four isomeric ions are similar but nevertheless characteristically different. For example, for ionized pyridine and its  $\alpha$ -distonic isomer  $\mathbf{1a}^{+\bullet}$ , the isomer distinction was realized on the basis of the  $m/z$  28 ( $\text{HC}=\text{NH}^+$ )/26 ( $\text{HC}\equiv\text{CH}^+$ ) peak branching ratio in their CID spectra: the pyridine radical cation is characterized by a ratio of  $0.41\pm 0.03$  whereas, in keeping with its structure,  $\mathbf{1a}^{+\bullet}$  yields a higher ratio:  $0.86\pm 0.03$ .

However, as shown in a recent preliminary study [8], a far easier differentiation between these two  $\text{C}_5\text{H}_5\text{N}^+$  ions is obtained in an associative ion–molecule reaction with dimethyl disulfide as the neutral reagent. Considering the ionization energies (IEs) of  $\mathbf{1a}$  and  $\mathbf{1}$  (6.8 and 9.3 eV [7]) vis à vis that of the disulfide (8.0 eV [9]), the pronounced difference in reactivity between the two ions, viz. a facile  $\text{CH}_3\text{S}^\bullet$  abstraction for  $\mathbf{1a}^{+\bullet}$  and charge exchange for  $\mathbf{1}^{+\bullet}$ , becomes readily understandable.

Another prime candidate for further analysis by associative ion–molecule reactions concerns the related  $\text{C}_6\text{H}_7\text{N}^+$  system of ions, viz. ionized 2-methylpyridine,  $\mathbf{2}^{+\bullet}$ , and its isomers,  $\mathbf{2a}^{+\bullet}$ , the *N*-methylene pyridinium ylide ion,  $\mathbf{2b}^{+\bullet}$ , the 2-methylene-1-

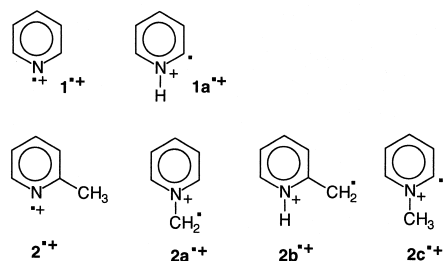

Scheme 1.

hydropyridine ion, and  $\mathbf{2c}^{+\bullet}$ , the *N*-methyl-2-dehydropyridine radical cation (Scheme 1).

As shown in a recent detailed experimental study [10], these four stable isomers can be differentiated on the basis of small structurally characteristic intensity differences in their high-energy CID spectra but only when the spectra are obtained under exactly the same, carefully defined, experimental conditions.

In light of the promising result on the pyridine system reported in [8], we report here a more detailed characterization of the  $\text{C}_5\text{H}_5\text{N}^+$  ions,  $\mathbf{1}^{+\bullet}$  and  $\mathbf{1a}^{+\bullet}$ , and also the  $\text{C}_6\text{H}_7\text{N}^+$  ions,  $\mathbf{2}^{+\bullet}$ ,  $\mathbf{2a}^{+\bullet}$ ,  $\mathbf{2b}^{+\bullet}$ , and  $\mathbf{2c}^{+\bullet}$  by studying their associative ion–molecule reactions with several neutral reagents including water, methanol, dimethyl disulfide, pyridine-*d*<sub>5</sub>, isopropyl iodide, and tert-butyl isocyanide. Some of these molecules are recognized as excellent trapping agents of distonic ions [3a,3b].

## 2. Experimental

The spectra were recorded on a six sector tandem mass spectrometer (Micromass AutoSpec 6F, Manchester) of  $\text{E}_1\text{c}_1\text{B}_1\text{c}_2\text{E}_2\text{c}_3\text{c}_4\text{E}_3\text{B}_2\text{c}_5\text{E}_4$  geometry (E = electric sector, B = magnetic sector, c = collision cell) [11]. General conditions were 8 kV accelerating voltage, 200  $\mu\text{A}$  trap current (in the electron ionization mode, EI), 1 mA (in the chemical ionization mode, CI), 70 eV ionizing electron energy and 200 °C ion source temperature. The solid samples were introduced with a direct insertion probe, while the liquid samples were injected into the ion source by means of a heated (180 °C) septum inlet.

The instrument has been modified with an rf-only



quadrupole collision cell (Qcell) between  $E_2$  and  $E_3$  as reported elsewhere [12]. This modification allows the study of associative ion–molecule reactions and the study of collision induced dissociation of decelerated ions having 20–30 eV kinetic energy. Briefly, the experiments utilizing the quadrupole consist of the selection of a beam of fast moving ions (8 keV) with the three first sectors ( $E_1B_1E_2$ ), the deceleration of these ions to  $\sim 5$  eV (to maximize ion–molecule reactions) or 20–30 eV (to maximize collision induced dissociations). The interaction between the ions and the reagent gas (the pressure of the gas is estimated to be about  $10^{-3}$  Torr) is thereafter realized in the Qcell and, after reacceleration to 8 keV, all the ions generated in the quadrupole are separated and mass measured by scanning the field of the second magnet. The high-energy CA spectra of mass-selected ions generated in the Qcell can be recorded by a linked scanning of the fields of the three last sectors. The pressure of the neutral reagent in the quadrupole collision cell cannot be reliably measured as it is estimated using an ionization gauge situated quite far away from the quadrupole cell. For the sake of consistency, an ion transmission of 50% was used in all experiments.

All samples were commercially available (Aldrich, Resco Trade) and used without further purification, except for 2-methylthiopyridine [13a] and methyl-2-pyridinethiocarboxylate [13b] which were prepared according to literature procedures.

### 3. Results and discussion: the $C_5H_5N^+$ radical cations $1^{++}$ and $1a^+$

#### 3.1. Preparation of the ions

Pyridine molecular ions  $1^{++}$  are conveniently generated by electron ionization of neutral pyridine whereas the  $\alpha$ -distonic isomer  $1a^+$  can be obtained by dissociative ionization from various precursor molecules. These include 2-picolinic acid (loss of  $CO_2$ ) [7a], methyl picolinate (loss of  $CH_2=O + CO$ ) [7b], and 2-acetylpyridine (loss of  $CH_2=C=O$ ) [8] which was used in the present study.

	 $1^{++}$	 $1a^+$
$H_2O$	-	95 – 0.3 97 – 0.01
$CH_3OH$	-	95 – 0.5 96 – 0.2 111 – 0.3
tert- $C_4H_9NC$	57 <sup>a</sup> – 0.1 <sup>b</sup> 105 – 0.4	57 – 0.6 105 – 3.5
iso- $C_3H_7I$	122 – 0.7 170 – 7 206 – 1	170 – 1 206 – 6
$CH_3SSCH_3$	94 – 8 126 – 0.08	94 – 0.7 126 – 2

<sup>a</sup> mass-to-charge ratios of the ion–molecule reactions products

<sup>b</sup> intensities of the reactions products signals relative to the intensity of the precursor ion = 100

#### 3.2. Ion–molecule reactions with dimethyl disulfide

As mentioned in Sec. 1, the bimolecular interaction of radical cations  $1^{++}$  and  $1a^+$  with dimethyl disulfide has been reported previously [8]. For the sake of comparison with the new results, we briefly summarize the observations of that study (Table 1).

The  $1a^+$  radical cations react with dimethyl disulfide in the quadrupole cell by abstraction of  $CH_3S^{\cdot}$  ( $m/z$  126, 2%) and to a lesser extent by charge exchange ( $m/z$  94, 0.7%) (Scheme 2). As expected, the reaction between the pyridine ions  $1^{++}$  and the neutral reagent differs: the charge exchange reaction now becomes the dominant process ( $m/z$  94, 8%). To verify the proposed structure of the  $[1a + CH_3S]^+$  ions at  $m/z$  126, their 8 keV CID spectrum was obtained and found to be very similar to that of protonated 2-methylthiopyridine.

In agreement with its prominence, the reaction  $1a^+ + CH_3SSCH_3 \rightarrow [1a + CH_3S]^+ + CH_3S^{\cdot}$  is estimated to be exothermic, by  $\sim 110$  kJ/mol. (From  $\Delta H_f(1a^+) = 995$  kJ/mol [7b],  $\Delta H_f(CH_3SSCH_3) = -24$

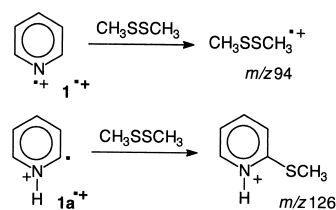

Scheme 2.

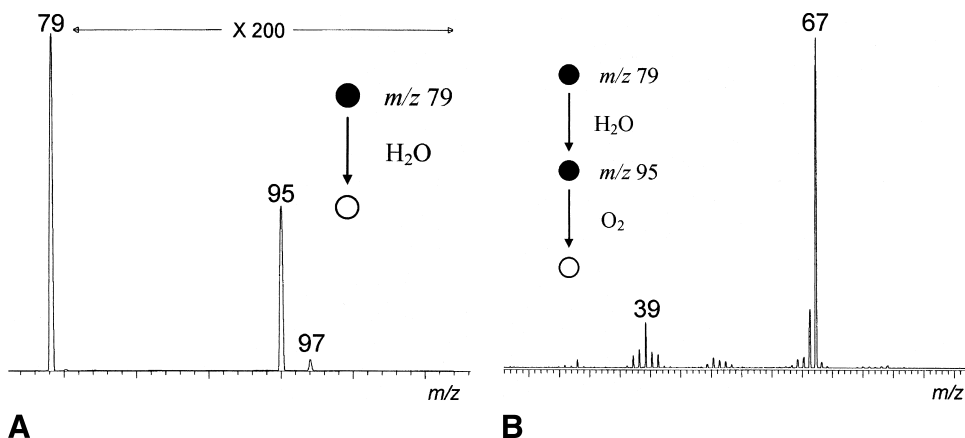

Fig. 1. Ion–molecule reactions between  $\mathbf{1a}^+$  radical cations ( $m/z$  79) and water: (a) mass spectrum of the ions produced in the quadrupole collision cell and (b) subsequent collision induced dissociation ( $\text{O}_2$ –8000 eV) of the  $m/z$  95 radical cations. The terminology, introduced by Schwartz et al. [37] is used to schematize the sequence of reactions: a filled circle represents a fixed (or selected) mass; an open circle, a variable (or scanned) mass, whereas the neutral reagent or collision gas that causes the mass transitions is shown between the circles.

kJ/mol,  $\Delta H_f([\mathbf{1a}+\text{CH}_3\text{S}]^+)=739$  kJ/mol and  $\Delta H_f(\text{CH}_3\text{S}^+)=123$  kJ/mol [14]). Charge exchange with the disulfide is endothermic with  $\mathbf{1a}^+$  (by 115 kJ/mol) and exothermic with  $\mathbf{1}^+$  (by 120 kJ/mol) and this too is reflected in the observed signal intensities for the  $m/z$  94 ion. In light of these thermochemical estimates, it is remarkable that the distonic ion undergoes a charge exchange reaction at all. We note, however, that in our experiments the mass-selected ions are not thermalized prior to the reactions in the quadrupole and this may explain why endothermic processes are also observed. Another point is that the calculated barrier for the 1,2-H shift connecting  $\mathbf{1}^+$  and  $\mathbf{1a}^+$  (265 kJ/mol [7b]) lies below the threshold for the loss of HCN, the dissociation reaction of lowest energy requirement (385 kJ/mol [15]). Thus, one may argue that both the pyridine radical cation,  $\mathbf{1}^+$ , and its distonic isomer,  $\mathbf{1a}^+$ , contain (minor) contributions from the other isomer. This would be so even if the ions had been thermalized prior to the reaction in the quadrupole cell. However, since the ions are not thermalized in our experiments, it remains unclear whether the  $m/z$  126 ions in the spectrum of  $\mathbf{1}^+$  and the  $m/z$  94 ions in the spectrum of  $\mathbf{1a}^+$  (Table 1) are due to the presence of isomeric “impurities.”

### 3.3. Ion–molecule reactions with $\text{H}_2\text{O}$ and $\text{CH}_3\text{OH}$

Water and methanol have only been used occasionally in the study of ion–molecule reactions with distonic ions. The reactivity of  $\text{CH}_2\text{CH}_2\text{OH}_2^+$  radical cations with water has been investigated by Kenttämä and co-workers who showed that this distonic ion undergoes a thermoneutral exchange of a water molecule when reacted with  $^2\text{H}$ - or  $^{18}\text{O}$ -labeled water [16]. The facile replacement of water with labeled water in the distonic ion was suggested to be in accordance with the predicted low barrier for the isomerization of this ion to an ion–dipole complex of ionized ethylene and water [17].

When the  $\alpha$ -distonic ions  $\mathbf{1a}^+$  are allowed to interact with water in the quadrupole collision cell, see Fig. 1(a),  $m/z$  95 ions are readily generated in a reaction which formally involves abstraction of the oxygen atom from the water molecule [18]. Under these conditions, pyridine radical cations  $\mathbf{1}^+$  are completely unreactive.

The CID spectrum of these  $m/z$  95 ions, shown in Fig. 1(b), is closely similar to that of the molecular ions in the EI spectrum of the 2-hydroxypyridine/pyridine-2-one system of protomeric isomers  $\mathbf{3a}/\mathbf{3b}$ .

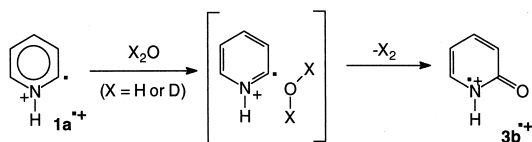

Scheme 3.

Although protomer  $\mathbf{3a}$  is the major isomer in the vapour phase [19a], it is highly probable [19b] that a facile interconversion between the ionic tautomers  $\mathbf{3a}^{\cdot+}/\mathbf{3b}^{\cdot+}$  precedes the CID analysis.

To remove the resulting ambiguity in the structure assignment of the  $m/z$  95 ions generated in the ion-molecule reaction, we replaced the water molecule by  $D_2O$ . In this experiment only one signal was observed, at  $m/z$  95, showing that the abstraction involves the specific loss of the water hydrogen atoms and that the product ion generated has the (initial) structure of the keto-isomer  $\mathbf{3b}^{\cdot+}$  as depicted in Scheme 3. We further note that the hydrogen atoms are probably lost as  $H_2$  rather than  $H \cdot + H \cdot$ . This is because the latter reaction is highly endothermic whereas the reaction  $\mathbf{1a}^{\cdot+} + H_2O \rightarrow \mathbf{3b}^{\cdot+} + H_2$  is calculated to be slightly exothermic (from  $\Delta H_f[\mathbf{1a}^{\cdot+}] = 995$  kJ/mol [7a];  $\Delta H_f[\mathbf{3b}^{\cdot+}] = 733$  kJ/mol [14a] (735 kJ/mol [14b]);  $\Delta H_f[H_2O] = -242$  kJ/mol and  $\Delta H_f[H_2] = 0$  kJ/mol [14]).

Methanol and  $CD_3OD$  behave in a completely analogous fashion: whereas the pyridine ions remain completely unreactive, the distonic isomer  $\mathbf{1a}^{\cdot+}$  again clearly yields  $m/z$  95 ions with a CID spectrum compatible with the formation of  $\mathbf{3b}^{\cdot+}$ . Here too, the overall reaction is calculated to be exothermic, by 136 kJ/mol, when it is assumed that  $CH_4$  is lost rather than  $CH_3 + H \cdot$ . In this context, we note that this remarkable abstraction process whose mechanism is currently being probed by further experiments, may have a precedent: diphenylcarbene radical cations interact with methanol in the condensed phase yielding benzophenone radical cations as one of the reaction products [20].

Finally, it follows from the summary of the experimental results in Table 1, that two more signals are present in the mass spectrum of the ion-molecule experiment of  $\mathbf{1a}^{\cdot+}$  with  $CH_3OH$ , at  $m/z$  111 and  $m/z$

96. These peaks correspond to  $[\mathbf{1a} + CH_3OH]^{\cdot+}$  and  $[\mathbf{1a} + OH]^{\cdot+}$  ions, respectively. Surprisingly, they do not seem to serve as precursors for the formation of the  $m/z$  95 ions  $\mathbf{3b}^{\cdot+}$  as a signal at  $m/z$  95 is only marginally present in their CID spectra.

### 3.4. Ion-molecule reactions with tert-butyl isocyanide

The reactivity of tert-butyl isocyanide toward distonic radical cations was recently examined by Kenttämäa and co-workers [21]. Two distinct reactivity patterns were observed, one characteristic of the electrophilic nature of the charge site of the ion, and the other characteristic of the unpaired spin of the free radical moiety. This neutral reagent reacts with charged groups by means of transfer of a cyanide ion, whereas a cyano radical is transferred to the radical site. These two types of reactivity are mutually exclusive due to great differences in reaction rates. Tert-butyl isocyanide reacts preferentially at the distonic ion's charge site and reaction occurs at the radical site only if the charge site is inert. The applicability of such a neutral reagent to the study of distonic radical cations has been clearly demonstrated [21].

Two reaction products are generated in the quadrupole cell when radical cations  $\mathbf{1a}^{\cdot+}$  are allowed to interact with neutral tert-butyl isocyanide:  $m/z$  105 ions (from cyano radical abstraction) and  $m/z$  57 ions (from a cyanide ion transfer), see Fig. 2(a). The reaction leading to the abstraction of  $CN^{\cdot}$  ( $m/z$  105) is more efficient than the reaction yielding tert-butyl cations ( $m/z$  57) as the ratio  $m/z$  105/ $m/z$  57 amounts to  $\sim 6$ . This result is in keeping with the findings of Kenttämäa and co-worker [21]: the charge site in radical cations  $\mathbf{1a}^{\cdot+}$  is coordinately saturated and can thus be considered as chemically inert. The charged pyridinium phenyl radical, studied in great detail by Kenttämäa and co-workers [22], provides an excellent example of such a chemical inertness of the distonic ion's charge site. In support of the mechanism depicted in Scheme 4, the CID spectrum of the  $m/z$  105 ions of Fig. 2(b) is closely similar to that of independently generated protonated 2-cyanopyridine.

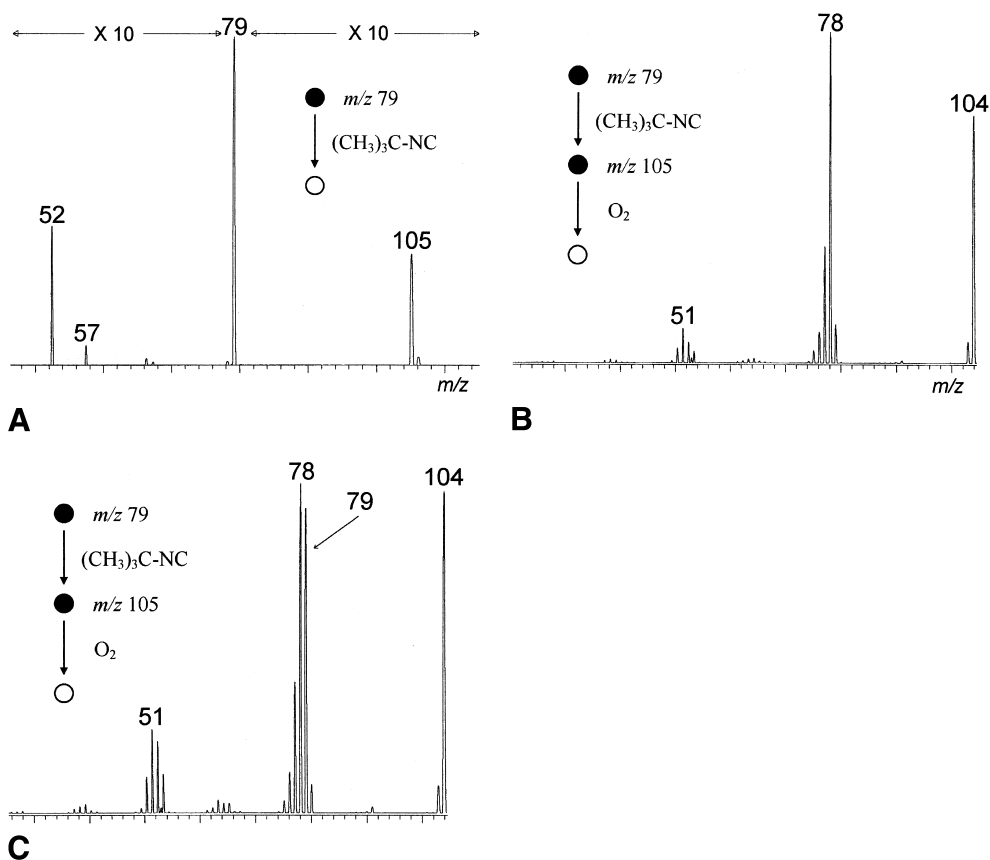
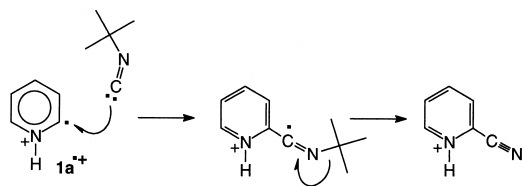

Fig. 2. Ion–molecule reactions between  $\mathbf{1a}^{+\bullet}$  radical cations ( $m/z$  79) and tert-butyl isocyanide: (a) mass spectrum of the ions produced in the quadrupole collision cell and (b) subsequent collision-induced dissociation ( $\text{O}_2$ –8000 eV) of the  $m/z$  105 ions. Ion–molecule reactions between pyridine radical cations  $\mathbf{1}^{+\bullet}$  ( $m/z$  79) and tert-butyl isocyanide: (c) subsequent collision-induced dissociation ( $\text{O}_2$ –8000 eV) of the  $m/z$  105 ions.

In contrast to its inertness in reactions with water and methanol discussed in Sec. 3.3, the pyridine molecular ions  $\mathbf{1}^{+\bullet}$  do react with tert-butyl isocyanide, generating ions at  $m/z$  57 and  $m/z$  105. However, these reactions are clearly less efficient than those observed with the distonic ion  $\mathbf{1a}^{+\bullet}$ . Although the signal at  $m/z$  105 represents 3.5% of the base peak ( $m/z$  79) when

ions  $\mathbf{1a}^{+\bullet}$  are transmitted to the quadrupole cell, this yield decreases to about 0.4% with the molecular ions of pyridine. Moreover, a consecutive CID experiment, see Fig. 2(c), reveals that the  $m/z$  105 ions generated from ionized pyridine do not have the protonated 2-cyanopyridine structure. These ions rather represent a less stable *N*-cyano species which is prone to lose  $\text{CN}^-$  ( $m/z$  79).



Scheme 4.

### 3.5. Ion–molecule reactions with isopropyl iodide

Alkyl iodides have relatively low homolytic C–I bond dissociation energies, in the 170–250 kJ/mol range [23]. Iodine atom abstraction is therefore often observed when free alkyl radicals are allowed to react



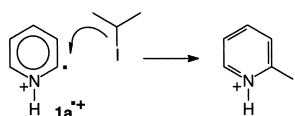

Scheme 5.

with an alkyl iodide [24]. Hence, the bimolecular reactivity of several distonic ions toward alkyl or allyl iodides has been thoroughly investigated. For instance, the distonic ion  $\cdot\text{CH}_2\text{CH}_2\text{CH}_2\text{C}^+\text{O}$  readily abstracts an iodine atom from isopropyl iodide, most likely by way of a direct attack at the radical site of the distonic ion [25]. However, the competitive abstraction of a  $\text{C}_3\text{H}_7$  radical is also observed [26]. This has been rationalized on the basis of a mechanism involving “catalysis” by the charge site of the radical cation: initial bond formation at the charge site would be followed by a radical substitution through a six-membered transition state [26]. Distonic ions like  $(\text{CH}_3)_2\text{S}^+-\text{CH}_2$  [25] and charged pyridinium phenyl radicals [27] also readily abstract I, but not  $\text{C}_3\text{H}_7$ , from  $\text{C}_3\text{H}_7\text{I}$ . These ions cannot form an additional bond at their charge site because it is coordinately saturated and thus, in support of the proposed catalysis mechanism, loss of  $\text{C}_3\text{H}_7$  is not realized.

As far as radical cations  $\mathbf{1a}^+$  are concerned, they react in the quadrupole with isopropyl iodide by iodine atom adduct formation ( $m/z$  206, 6%) and to a lesser extent also by charge exchange ( $m/z$  170, 1% of the  $m/z$  79 base peak). The IE of  $\mathbf{1a}$ , 6.8 eV [7b], is considerably lower than that of  $\text{C}_3\text{H}_7\text{I}$ , 9.2 eV [14], and thus the charge exchange leading to  $m/z$  170  $\text{C}_3\text{H}_7\text{I}^+$  ions either reflects the fact that the ions are not thermalized or else the presence of  $\mathbf{1}^+$  as an isomeric impurity, see Sec. 3.2.

The collision-induced dissociations of the  $m/z$  206 ions generated in the quadrupole indicate that they have the structure of protonated 2-iodopyridine, see Scheme 5. Another very interesting finding is that  $m/z$  122 cations resulting from isopropyl radical abstraction are not observed, in line with the coordinative saturation of the pyridinium charge site in  $\mathbf{1a}^+$  [26,27].

Ionized pyridine,  $\mathbf{1}^+$ , on the other hand, undergoes both abstraction of an iodine atom ( $m/z$  206, 1%) and

an isopropyl radical ( $m/z$  122, 0.7%). However, the charge exchange reaction leading to  $m/z$  170 ions (7%) is clearly the predominant process. This is not surprising considering that the IE of pyridine (9.3 eV) is slightly higher than that of isopropyl iodide (9.2 eV). Charge exchange reactions that are exothermic can be expected to be very fast: the reported rate constants for most exothermic charge exchange reactions are close to the capture collision limit [28].

In summary we note, see Table 1, that isopropyl iodide allows an even better differentiation of the isomeric ions  $\mathbf{1}^+$  and  $\mathbf{1a}^+$  than tert-butyl isocyanide.

#### 4. Results and discussion: the $\text{C}_6\text{H}_7\text{N}^+$ radical cations $\mathbf{2}^+$ , $\mathbf{2a}^+$ , $\mathbf{2b}^+$ , and $\mathbf{2c}^+$

##### 4.1. Preparation of $\text{C}_6\text{H}_7\text{N}^+$ radical cations

Ionized 2-picoline,  $\mathbf{2}^+$ , is prepared by electron ionization of the stable neutral molecule. The *N*-methylene pyridinium ylide ion,  $\mathbf{2a}^+$ , can be produced by dissociative ionization of bis(ethoxycarbonyl)pyridinium methylene [29]. The ion can also conveniently be generated by  $\text{CH}_2^+$  transfer from oxirane ions to neutral pyridine under conditions of chemical ionization [30]. Oxirane, upon electron impact ionization spontaneously undergoes a ring opening into the distonic ion  $\cdot\text{CH}_2\text{OCH}_2^+$  [31], which has been reported to be an efficient methylene transfer agent [3a,3b,32]. Ionized ketene [33] and cyclobutanone [25] (by means of its distonic isomer  $\cdot\text{CH}_2\text{CH}_2\text{CH}_2\text{C}^+\text{O}$  [34]) also react with several neutral molecules by  $\text{CH}_2^+$  transfer. In this work, we have used cyclobutanone to generate  $\mathbf{2a}^+$  by  $\text{CH}_2^+$  transfer to pyridine.

The decarbonylation of 2-acetylpyridine ions [10] and the loss of formimine ( $\text{CH}_2=\text{NH}$ ) from 2-dimethylaminopyridine ions [29] provide convenient routes for the generation of isomerically pure ions  $\mathbf{2b}^+$ . In this study we have used the second of these dissociative electron impact procedures.

Isomer  $\mathbf{2c}^+$  can be generated by either dissociative electron ionization, loss of OCS from methyl-2-pyridinethiocarboxylate ions [13] or by collision in-

duced dechlorination of *N*-methylated 2-chloropyridine ions as described in [8]. The former procedure was used in this study.

#### 4.2. Ion–molecule reactions with $H_2O$ and $CH_3OH$





Of the four  $C_6H_7N^+$  isomeric radical cations studied, only the carbenic species  $2c^+$  reacts with water, yielding  $m/z$  109 ions by a formal abstraction of atomic oxygen. Analogous to the behaviour of the pyridine type ion  $1a^+$  discussed previously, the use of  $D_2O$  as the neutral reagent shows that the leaving hydrogens are those of the water molecule. The structure of the  $m/z$  109 ions was established to be that of ionized *N*-methyl-2-pyridone by comparative CID experiments. That the  $CH_3$  group in ions  $2c^+$  does not participate in this remarkable abstraction reaction follows from ion–molecule reactions with methanol and  $CD_3OD$  which exclusively yield  $m/z$  109 ions having the structure of ionized *N*-methyl-2-pyridone.

Thus interaction of the above-mentioned  $C_6H_7N^+$  isomers with water (or methanol) allows one to unambiguously determine if the reacting species has the structure  $2c^+$ .

#### 4.3. Ion–molecule reactions with *tert*-butyl isocyanide

When  $2c^+$  ions are transmitted to the quadrupole cell pressurized with *tert*-butyl isocyanide, ions at  $m/z$  57 (0.2%) and  $m/z$  119 (2.2%) are produced. These ion–molecule reaction products arise from a  $CN^-$  transfer and a  $CN^{\cdot}$  abstraction, respectively. The  $m/z$  119 signal resulting from the radical abstraction is more intense than that of the cationic reaction, in keeping with the chemical inertness of the cationic site in ions  $2c^+$  (see Sec. 3.4). The CID spectrum of the  $m/z$  119 ions features structure diagnostic signals such as  $m/z$  104 (loss of  $CH_3$ ) and  $m/z$  93 (loss of  $CN^{\cdot}$ ), and is compatible with the presence of *N*-methyl-2-cyanopyridine ions. In these experiments the isomeric ions  $2^+$  and  $2b^+$  also generate  $m/z$  57 and 119 ions but, see Table 2, in negligible quantities.

In contrast, the pyridine *N*-methylene isomer  $2a^+$  reacts in a unique way with *tert*-butyl isocyanide

				
	$2^+$	$2a^+$	$2b^+$	$2c^+$
$H_2O$	-	-	-	109 – 0.3
$CH_3OH$	-	-	-	109 – 0.1
<i>tert</i> - $C_4H_9NC$	57 – 0.01 119 – 0.3	97 – 5	57 – 0.1 119 – 0.1	57 – 0.2 119 – 2.2
pyridine- $d_5$	-	98 – 0.3	-	-
iso- $C_3H_7I$	136 – 0.2 170 – 0.6 220 – 0.5	220 – 0.04	206 – 0.3	220 – 1
$CH_3SSCH_3$	94 – 11	140 – 0.02	140 – 0.02	94 – 2.3 140 – 1

<sup>a</sup> mass-to-charge ratios of the ion–molecule reactions products

<sup>b</sup> intensities of the reactions products signals relative to the intensity of the precursor ion = 100

which permits its unambiguous characterization. An ionized methylene is readily transferred from the  $2a^+$  ions to the neutral isocyanide, yielding the  $m/z$  97 ions shown in Fig. 3(a). That these ions have the expected ketenimine structure,  $(CH_3)_3C-N=C=CH_2^+$ , follows from the CID spectrum of Fig. 3(b) which shows prominent peaks at  $m/z$  57 ( $(CH_3)_3C^+$ ) and  $m/z$  41 ( $H-N=C=CH_2^+$ , loss of isobutene). The transfer of a charged odd-electron group from a distonic ion to an isocyanide is not unprecedented. In fact the reaction has been frequently used to characterize distonic ions such as nitrile *N*-selenide ions [35], pyridine *N*-selenide ions [3h],  $C_2S_3^+$  radical cations [4] and ionized thiosulfoxides [3i]. We further note that an ionized ketenimine,  $CH_3-N=C=CH_2^+$  [2,3g] is also readily generated when methyl isocyanide interacts with ionized ketene or cyclobutanone.

#### 4.4. Ion–molecule reactions with isopropyl iodide

2-methylpyridine ions  $2^+$  react with isopropyl iodide by isopropyl radical abstraction ( $m/z$  136), charge exchange ( $m/z$  170) and iodine atom abstraction ( $m/z$  220). The charge exchange is clearly less pronounced than that observed in the parent pyridine ion  $1^+$  discussed in Sec. 3.5. This is because the process is exothermic for  $1^+$  and slightly endothermic for  $2^+$  ( $IE(2)=8.6$  eV [14]).

As expected for distonic ions  $2a^+$  and  $2c^+$ , both abstract an iodine atom to form  $m/z$  220 ions. This process appears to be much more efficient with ions  $2c^+$  than ions  $2a^+$ : 1% versus 0.04%, as measured



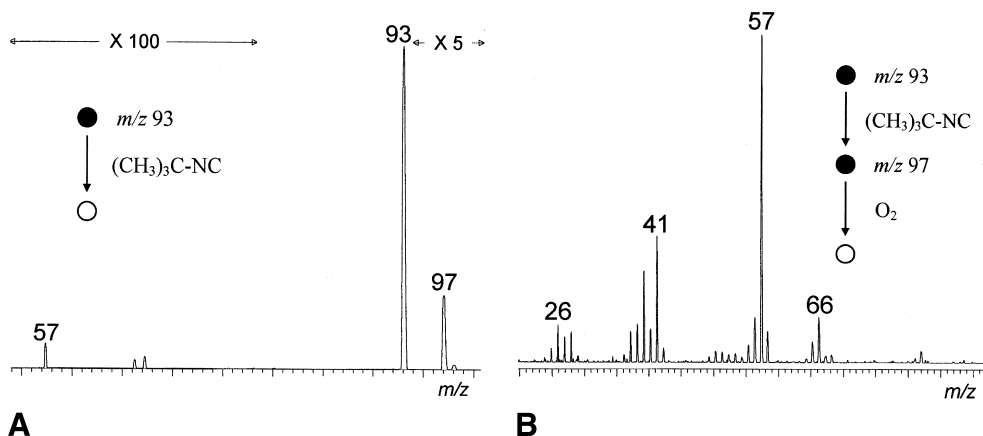

Fig. 3. Ion–molecule reactions between  $2a^{++}$  radical cations ( $m/z$  93) and tert-butyl isocyanide: (a) mass spectrum of the ions produced in the quadrupole collision cell and (b) subsequent collision-induced dissociation ( $O_2$ –8000 eV) of the  $m/z$  97 ions.

under experimental conditions that were kept rigorously constant. Moreover the CID spectra of the adduct ions are characteristically different, thus permitting the differentiation of  $2a^{++}$  and  $2c^{++}$ . The two CID spectra, see Fig. 4(a) and (b), show the same major dissociations but that of  $2a^{++}$  features a signature peak at  $m/z$  141, which, see Scheme 6, originates from the loss of pyridine.

Finally, ions  $2b^{++}$  show a very unexpected reaction:  $m/z$  206 ions are generated in a reaction that formally corresponds to the substitution of the  $CH_2$

moiety in the ion by iodine (see Fig. 5). That the resulting product ions are protonated 2-iodopyridine follows from the close similarity of its CID spectrum, with that of protonated 2-iodopyridine, discussed in Sec. 3.5. The mechanism of this remarkable reaction has not yet been investigated but the process clearly is uniquely characteristic of ions  $2b^{++}$ . We further note that  $I^-$  abstraction does not occur since  $m/z$  220 ions are not generated.

#### 4.5. Ion–molecule reactions with pyridine- $d_5$

In one of the earlier studies of *N*-methylene pyridine radical cations, Yu et al. [30b] describe the  $CH_2^+$  abstraction from ions  $2a^{++}$  by the more nucleophilic pyridine derivative, 2,6-dimethylpyridine. We have extended this interesting experiment to characterize the molecular ions of pyridine *N*-thioxide [3f] and

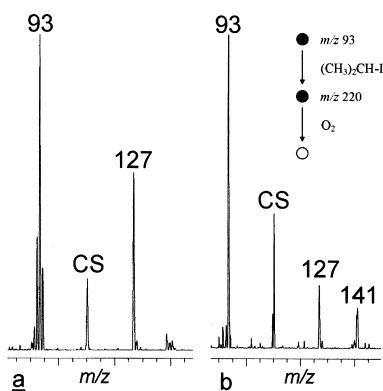
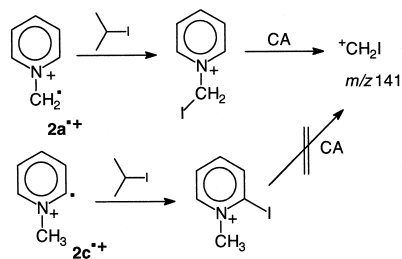

Fig. 4. (a) Ion–molecule reactions between  $2c^{++}$  radical cations ( $m/z$  93) and isopropyl iodide: subsequent collision induced dissociation ( $O_2$ –8000 eV) of the  $m/z$  220 cations. (b) Ion–molecule reactions between  $2a^{++}$  radical cations ( $m/z$  93) and isopropyl iodide: subsequent collision induced dissociation ( $O_2$ –8000 eV) of the  $m/z$  220 cations. (CS represents the charge stripping signal at  $m/z$  110).



Scheme 6.

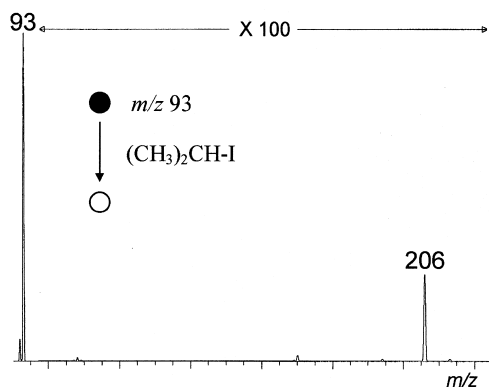

Fig. 5. Ion–molecule reactions between  $2b^+$  radical cations ( $m/z$  93) and isopropyl iodide: mass spectrum of the ions produced in the quadrupole collision cell.

pyridine *N*-selenide [3h]. In the same vein, the  $CH_2^+$  transfer observed in the reaction of the  $CH_3CNCH_2^+$  ion with pyridine- $d_5$  characterizes its distonic nature [3g]. As expected with the four isomeric ions in the present study, only the *N*-methylene pyridine ions  $2a^+$  show a  $CH_2^+$  transfer to pyridine- $d_5$ .

#### 4.6. Ion–molecule reactions with dimethyl disulfide

Analogous to the pyridine case, the 2-picoline molecular ions react predominantly by charge exchange ( $m/z$  94, 11%). This is not surprising as the ionization energy of 2-picoline (8.6 eV) is higher than that of the disulfide (8.0 eV). The charge exchange reaction is also observed when the reacting ions have the structure  $2c^+$ , but no  $m/z$  94 radical cations are detected with  $2a^+$  and  $2b^+$ . This can be attributed to the low IEs of the corresponding neutrals, 6.1 and 6.3 eV, respectively, as derived from the theoretical calculations of Lavorato et al. [7b].

A common reaction product of  $2a^+$ ,  $2b^+$  and  $2c^+$  is the adduct ion resulting from the expected  $CH_3S^+$  radical abstraction, characteristic of distonic ions, see Scheme 7. The structures of these ions were investigated by consecutive CID experiments. The CID spectrum of the  $[2a+CH_3S]^+$  ions is shown in Fig. 6(a) and is characteristic of the proposed structure,  $3a^+$  (Scheme 7). Peaks at  $m/z$  125 (loss of  $CH_3$ ),  $m/z$  93 (loss of  $CH_3S^+$ ) and  $m/z$  61 ( $CH_3SCH_2^+$ , loss of

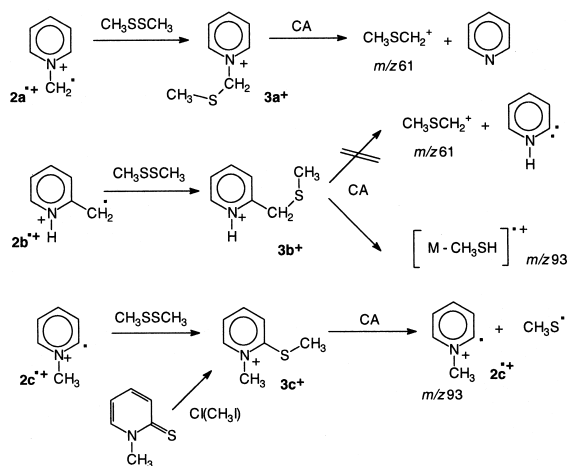

Scheme 7.

pyridine) are indeed in keeping with the  $3a^+$  structure. The CID spectrum of the adduct ions derived from  $2b^+$  is very different, see Fig. 6(b). The  $m/z$  92 base peak in this spectrum corresponds to the loss of methanethiol, which is a negligible fragmentation for ions  $3a^+$ . The absence of the signal at  $m/z$  61 ( $CH_3SCH_2^+$ ) is entirely compatible with the proposal that the sampled ions possess the  $3b^+$  structure, see Scheme 7. The production of  $CH_3SCH_2^+$  ions from  $3b^+$  would involve the energetically unfavourable elimination of the carbenic pyridine isomer **1a**. This neutral, the so-called Hammick intermediate [7a], is 210 kJ/mol higher in energy than its pyridine counterpart.

If the ions prepared from methyl-2-pyridinethio-carboxylate ions are indeed distonic ions  $2c^+$ , it is expected that abstraction of a methylthio radical produces ions  $3c^+$ , *N*-methyl-2-methylthiopyridine ions, see Scheme 7. The CID spectrum of this ion, see Fig. 6(c), is different from that of  $3a^+$  and  $3b^+$ . It is characterized by very intense signals at  $m/z$  125 and  $m/z$  93 corresponding to the losses of  $CH_3$  and  $CH_3S^+$ , respectively. The latter decomposition regenerates the initial distonic ion  $2c^+$ . Further, the CID spectrum of  $[2c+CH_3S]^+$  is virtually identical with that obtained on methylated 2-methylthiopyridine ions generated by the methylation of *N*-methyl-2-pyridine-thione [36], see Scheme 7, and this confirms the structure assignment.

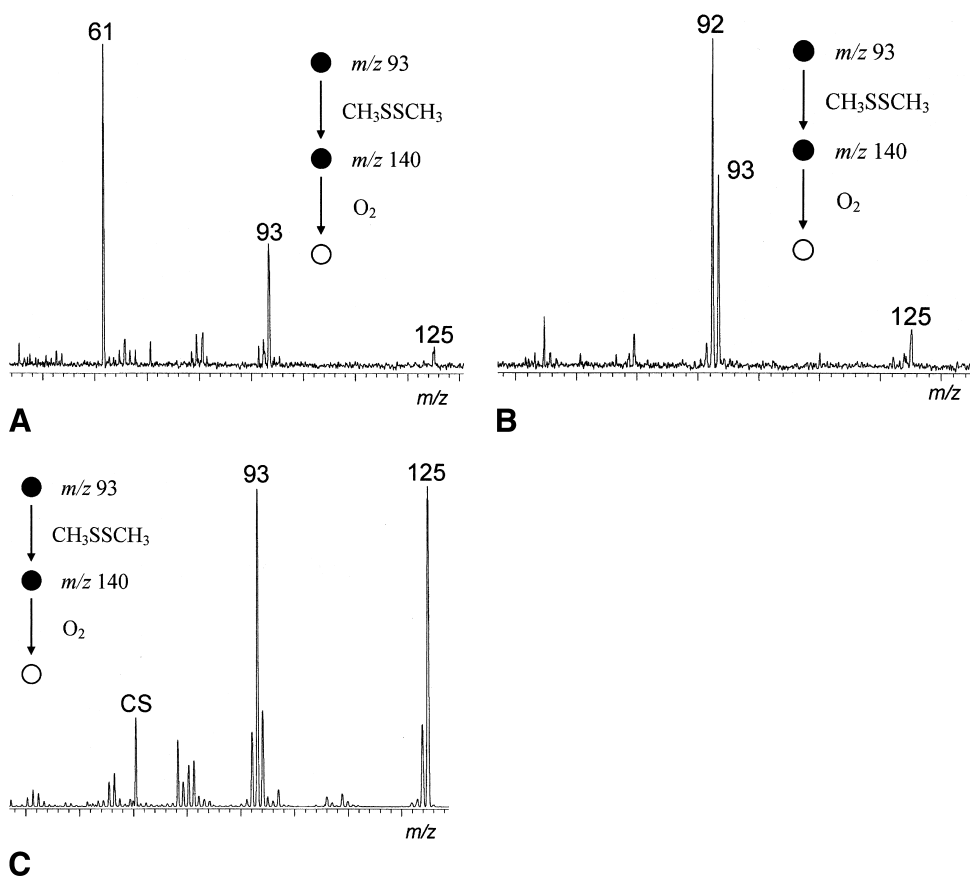

Fig. 6. Ion–molecule reactions between  $C_6H_7N^+$  radical cations ( $m/z$  93) and dimethyl disulfide. Collision-induced dissociation spectra of the  $m/z$  140 adduct ions generated from ions  $2a^+$ , item (a), ions  $2b^+$ , item (b) and ions  $2c^+$ , item (c).

## 5. Conclusions

Associative ion–molecule reactions with judiciously selected substrates in conjunction with CID experiments on the adducts provide a powerful tool to differentiate isomeric ions whose CID spectra are closely similar. Differentiation of the  $C_5H_5N^+$  isomers, ionized pyridine,  $1^+$ , and its carbenic isomer,  $1a^+$ , is readily realized as their reactivity is fundamentally different. Radical cations  $1a^+$  exhibit a radical-type reactivity that reflects its distonic character. For instance, they react with dimethyl disulfide by  $CH_3S^{\cdot}$  abstraction while the conventional isomer mainly reacts by charge exchange. An unexpected reaction was also discovered which involves the formal abstraction of an oxygen atom when  $1a^+$  ions

react with water or methanol. The mechanism of this reaction is currently under investigation.

As far as the picoline isomers  $2^+$ ,  $2a^+$ – $2c^+$  are concerned, their characterization can be achieved by using at least three neutral molecules, namely water (or methanol), tert-butyl isocyanide (or pyridine- $d_5$ ), and isopropyl iodide. Only the carbenic ions  $2c^+$  react with water (or methanol) by formal oxygen atom abstraction yielding ionized *N*-methyl-2-pyridone. The remaining isomers can then be subjected to a reaction with tert-butyl isocyanide (or pyridine- $d_5$ ) and a net ionized methylene transfer uniquely characterizes the pyridine *N*-methylene ions  $2a^+$ . Next, isopropyl iodide allows a clear distinction between  $2^+$  and  $2b^+$ . Ionized 2-picoline,  $2^+$ , performs the abstraction of the isopropyl radical whereas an un-

usual substitution reaction occurs when  $2b^{+}$  is allowed to react with isopropyl iodide. A formal substitution of methylene by iodine in ion  $2b^{+}$  is the only reaction observed. This unprecedented reaction leads to protonated 2-iodopyridine.

The distonic character of ions  $2a^{+}$ ,  $2b^{+}$ , and  $2c^{+}$  was also probed by their reactivity toward dimethyl disulfide. All three ions react with this reagent by thiomethyl radical abstraction. Consecutive CID experiments readily distinguish the produced adduct ions and interpretation of the spectra attests to the structures of the substrate ions in the ion-molecule reactions.

### Acknowledgements

Some of the authors (P.G., M.B.-F., and R.F.) thank the “Fonds National pour la Recherche Scientifique” for financial support in the acquisition of the tandem mass spectrometer. Another author (J.K.T.) thanks the Natural Sciences and Engineering Research Council of Canada (NSERC) for financial support and Moschoula A. Trikoupi for valuable discussions.

### References

- [1] J.L. Holmes, *Org. Mass Spectrom.* 20 (1985) 169.
- [2] K. Levsen, H. Schwarz, *Angew. Chem. Int. Ed. Engl.* 15 (1976) 509.
- [3] (a) H.I. Kenttämä, *Org. Mass Spectrom.* 29 (1994) 1; (b) K.M. Stirk, L.K.M. Kiminkinen, H.I. Kenttämä, *Chem. Rev.* 92 (1992) 1649; (c) L.A.B. Moraes, F.C. Gozzo, M.N. Eberlin, *J. Org. Chem.* 62 (1997) 5096; (d) M.N. Eberlin, R.G. Cooks, *J. Am. Chem. Soc.* 115 (1993) 9226; (e) B.J. Shay, M.N. Eberlin, R.G. Cooks, C. Wesdemiotis, *J. Am. Soc. Mass Spectrom.* 3 (1992) 518; (f) P. Gerbaux, Y. Van Haverbeke, R. Flammang, *J. Mass Spectrom.* 32 (1997) 1170; (g) P. Gerbaux, R. Flammang, M.T. Nguyen, J.-Y. Salpin, G. Bouchoux, *J. Phys. Chem. A* 102 (1998) 861; (h) P. Gerbaux, Y. Van Haverbeke, R. Flammang, *Int. J. Mass Spectrom.* 184 (1999) 39; (i) P. Gerbaux, J.-Y. Salpin, G. Bouchoux, R. Flammang, *ibid.* 195/196 (2000) 239.
- [4] P. Gerbaux, R. Flammang, C.Th. Pedersen, M.W. Wong, *J. Phys. Chem. A* 103 (1999) 3666.
- [5] C. Lifshitz, D. Gibson, K. Levsen, I. Dotan, *Int. J. Mass Spectrom. Ion Phys.* 40 (1981) 157.
- [6] For selected references see: (a) D.K. Böhme, *Int. J. Mass Spectrom. Ion Processes* 115 (1992) 95; (b) J.W. Gauld, H.-E. Audier, J. Fossey, L. Radom, *J. Am. Chem. Soc.* 118 (1996) 6299; (c) J.W. Gauld, L. Radom, *ibid.* 119 (1997) 9831; (d) A.J. Chalk, L. Radom, *ibid.* 119 (1997) 7573; (e) A.J. Chalk, L. Radom, *ibid.* 121 (1999) 1574; (f) M.A. Trikoupi, D. Lavorato, J.K. Terlouw, P.J.A. Ruttink, P.C. Burgers, *Eur. Mass Spectrom.* 5 (1999) 431; (g) J. Chamot-Rooke, G. van der Rest, P. Mourgues, H.-E. Audier, *Int. J. Mass Spectrom.* 195/196 (2000) 385.
- [7] (a) D. Lavorato, J.K. Terlouw, T.K. Dargel, W. Koch, G.A. McGibbon, H. Schwarz, *J. Am. Chem. Soc.* 118 (1996) 11898; (b) D. Lavorato, J.K. Terlouw, T.K. Dargel, G.A. McGibbon, W. Koch, H. Schwarz, *Int. J. Mass Spectrom.* 179/180 (1998) 7.
- [8] P. Gerbaux, M. Barbieux-Flammang, Y. Van Haverbeke, R. Flammang, *Rapid Commun. Mass Spectrom.* 13 (1999) 1707.
- [9] D.T. Leeck, H.I. Kenttämä, *Org. Mass Spectrom.* 29 (1994) 106.
- [10] D.J. Lavorato, L.M. Fell, G.A. McGibbon, S. Sen, J.K. Terlouw, H. Schwarz, *Int. J. Mass Spectrom.* 195/196 (2000) 71.
- [11] R.H. Bateman, J. Brown, M. Lefevre, R. Flammang, Y. Van Haverbeke, *Int. J. Mass Spectrom. Ion Processes* 115 (1992) 205.
- [12] R. Flammang, Y. Van Haverbeke, C. Braybrook, J. Brown, *Rapid Commun. Mass Spectrom.* 9 (1995) 795.
- [13] (a) J. Renault, *Ann. Chim. (Paris)* 10 (1955) 135; (b) H. Budzikiewicz, E. Lange, W. Ockels, *Phosphorus Sulfur* 11 (1981) 33.
- [14] (a) S.G. Lias, J.E. Bartmess, L.F. Liebman, J.L. Holmes, R.D. Levin, W.G. Mallard, *J. Phys. Chem. Ref. Data* 17 Suppl.1 (1988); (b) J.K. Wolken, F. Turecek, *J. Phys. Chem. A* 103 (1999) 6268.
- [15] J.H. Beynon, J.A. Hopkinson, G.R. Lester, *Int. J. Mass Spectrom. Ion Phys.* 2 (1969) 291.
- [16] K.G. Stirk, H.I. Kenttämä, *J. Phys. Chem.* 96 (1992) 5272.
- [17] R. Postma, P.J.A. Ruttink, B. Van Baar, J.K. Terlouw, J.L. Holmes, P.C. Burgers, *Chem. Phys. Lett.* 123 (1986) 409.
- [18] The reaction between ionized pyridine and ozone also leads to the abstraction of an oxygen atom, yielding pyridine N-oxide molecular ions: M.A. Mendes, L.A.B. Moraes, R. Sparrapan, M.N. Eberlin, R. Kostianen, T. Kotiaho, *J. Am. Chem. Soc.* 120 (1998) 7869.
- [19] (a) P. Beak, F.S. Fry Jr., J. Lee, F. Steele, *J. Am. Chem. Soc.* 98 (1976) 171; (b) A. Maquestiau, Y. Van Haverbeke, C. De Meyer, A.R. Katritzky, M.J. Cook, A.D. Page, *Can. J. Chem.* 53 (1975) 490.
- [20] (a) V.D. Parker, D. Bethell, *J. Am. Chem. Soc.* 109 (1987) 5066; (b) D. Bethell, V.D. Parker, *Acc.Chem.Res.* 21 (1988) 400.
- [21] E.D. Nelson, R. Li, H.I. Kenttämä, *Int. J. Mass Spectrom.* 185/186/187 (1999) 91.
- [22] (a) R.L. Smith, H.I. Kenttämä, *J. Am. Chem. Soc.* 117 (1995) 1393; (b) K. Thoen, R.L. Smith, J.J. Nousiainen, E.D. Nelson, H.I. Kenttämä, *ibid.* 118 (1996) 8669; (c) K.K. Thoen, H.I. Kenttämä, *ibid.* 119 (1997) 3832.
- [23] J.A. Seetula, J.J. Russell, D. Gutman, *J. Am. Chem. Soc.* 112 (1990) 1347.

- [24] H. Sidebottom, J. Treacy, *Int. J. Chem. Kinet.* 16 (1984) 579.
- [25] R.L. Smith, L.J. Chyall, K.M. Stirk, H.I. Kenttämäa, *Org. Mass Spectrom.* 28 (1993) 1623.
- [26] K.M. Stirk, R.L. Smith, J.C. Orłowski, H.I. Kenttämäa, *Rapid Commun. Mass Spectrom.* 7 (1993) 392.
- [27] J.L. Heidbrink, K.K. Thoen, H.I. Kenttämäa, *J. Org. Chem.* 65 (2000) 645.
- [28] A.G. Harrison, *Chemical Ionization Mass Spectrometry*, CRC Press, Boca Raton, FL, 1983.
- [29] R. Flammang, O. Thoelen, C. Quattrocchi, J.-L. Bredas, *Rapid Commun. Mass Spectrom.* 6 (1992) 135.
- [30] (a) C.G. De Koster, J.J. Van Houte, J. Van Thuijl, *Int. J. Mass Spectrom. Ion Processes* 98 (1990) 235; (b) S.J. Yu, M.L. Gross, K.R. Fountain, *J. Am. Soc. Mass Spectrom.* 4 (1993) 117; (c) F.C. Gozzo, M.N. Eberlin, *ibid.* 6 (1995) 554.
- [31] (a) W.J. Bouma, J.K. MacLeod, L. Radom, *J. Chem. Soc. Chem. Commun.* (1978) 724; (b) W.J. Bouma, J.K. MacLeod, L. Radom, *J. Am. Chem. Soc.* 101 (1979) 5540.
- [32] (a) M.W. van Amsterdam, H.W. Zappey, S. Ingemann, N.M.N. Nibbering, *Org. Mass Spectrom.* 28 (1993) 30; (b) R.R. Corderman, P.R. LeBreton, S.E. Buttrill, A.D. Williamson, J.L. Beauchamp, *J. Chem. Phys.* 65 (1976) 4929; (c) C.G. De Koster, J.J. Van Houte, J.B. Shadid, J. Van Thuijl, *Rapid Commun. Mass Spectrom.* 2 (1995) 97; (d) W.J. Bouma, J.K. MacLeod, L. Radom, *Adv. Mass Spectrom.* 8 (1980) 178; (e) C.G. De Koster, J.J. Van Houte, J. Van Thuijl, *Int. J. Mass Spectrom. Ion Processes* 123 (1993) 59; (f) 134 (1994) 1; (g) 137 (1994) 67; (h) R.D. Rusli, H. Schwarz, *Chem. Ber.* 123 (1990) 535.
- [33] T. Drewello, N. Heinrich, W.P.M. Maas, N.M.N. Nibbering, T. Weiske, H. Schwarz, *J. Am. Chem. Soc.* 109 (1987) 4810.
- [34] (a) N. Heinrich, W. Koch, J.C. Morrow, H. Schwarz, *J. Am. Chem. Soc.* 110 (1988) 6332; (b) C. Dass, M.L. Gross, *Org. Mass Spectrom.* 25 (1990) 24; (c) P.J. Boon, M.C.R. Symons, K. Ushida, T. Shida, *J. Chem. Soc. Perkin Trans. 2* (1984) 1213.
- [35] P. Gerbaux, R. Flammang, E.H. Mørkved, M.W. Wong, C. Wentrup, *J. Phys. Chem. A* 102 (1998) 9021.
- [36] R. Houriet, E. Rolli, R. Flammang, A. Maquestiau, G. Bouchoux, *Org. Mass Spectrom.* 22 (1987) 770.
- [37] J.C. Schwartz, A.P. Wade, C.G. Enke, R.G. Cooks, *Anal. Chem.* 62 (1990) 1809.